

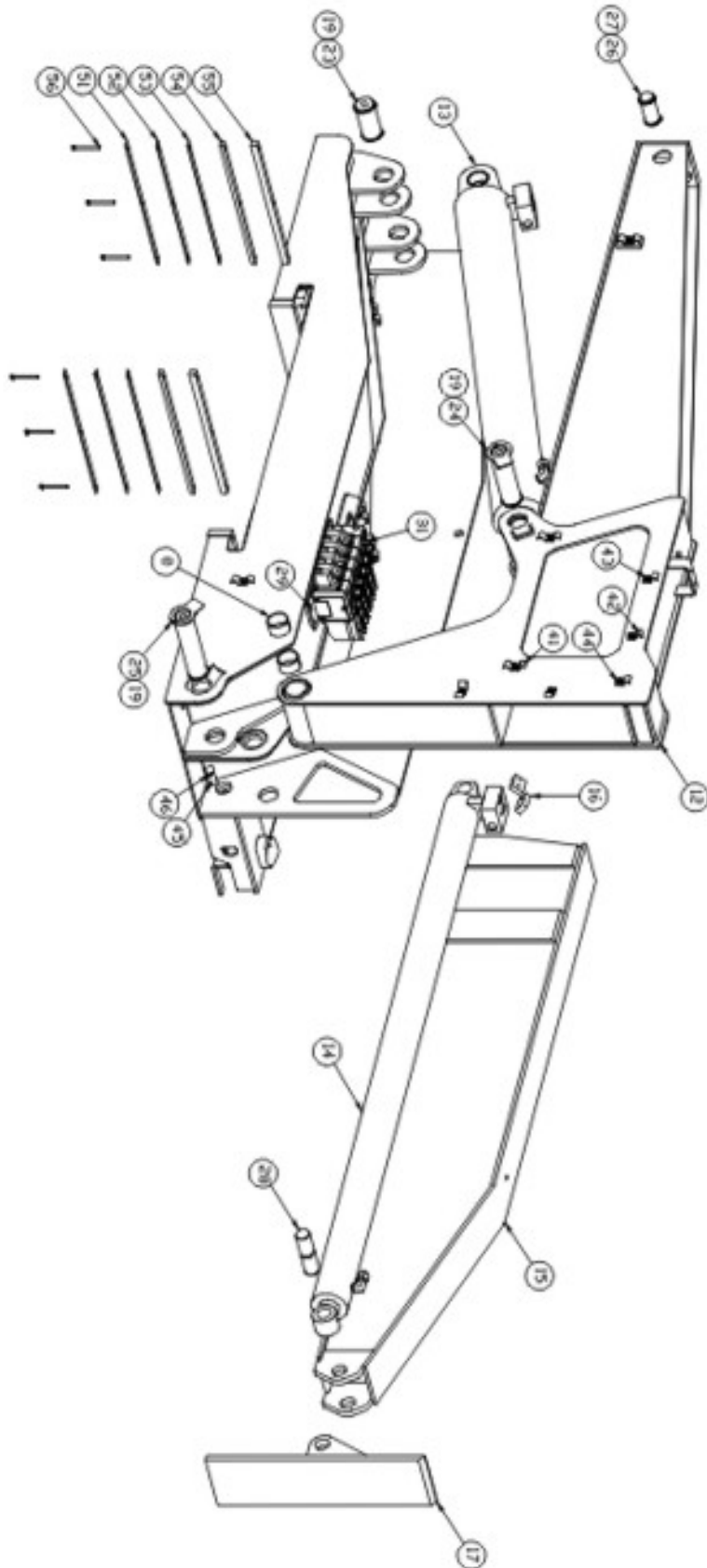

Crane Assembly SB300

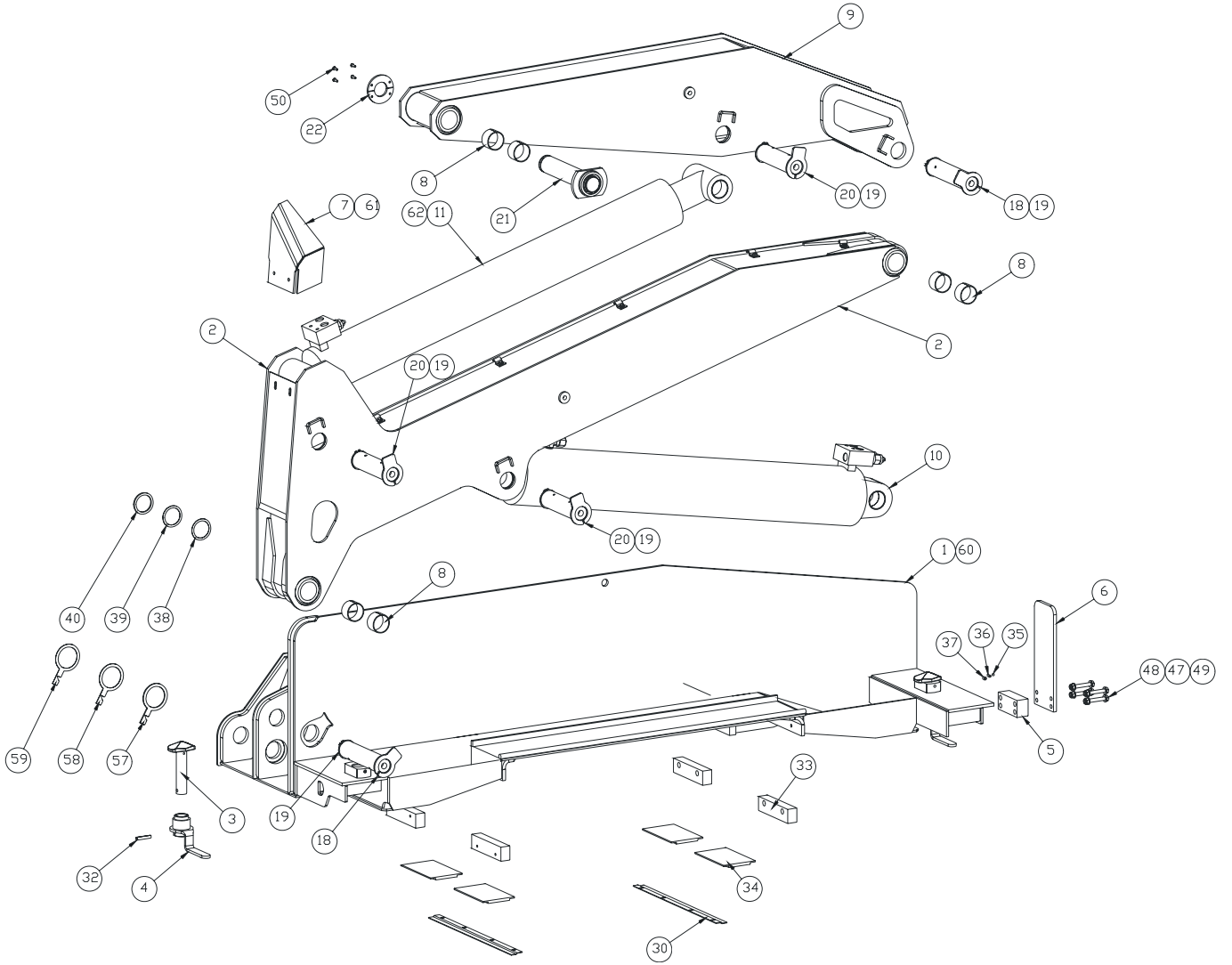





Note: Please provide the Serial Number of the Sidelifter with all spare parts orders.

Item	Part Number	Description (SB300)	Qty
1	S3-25980	Crane Base L/H SB33	1
2	S3-25928	Arm Bottom SB33	1
3	S3-26034	Centre Twistlock Crane Base SB33	2
4	S3-26040	Handle Twistlock Crane Base SB33	2
5	S3-26044	Block Spring Offside Bash Plate SB33	1
6	S3-26048	Plate Bash Offside Crane Base SB33	1
7	S3-25963	Plate Bash Bottom Arm L/H SB33	1
8	BE-29011	Bearing Glacier 60 ID x 40 long	8
9	S3-25938	Arm Top SB33	1
10	HC-30051	kit Cylinder Hyd Bottom Lift SB30	1
11	HC-26059	Kit Cylinder Hyd Top Lift L/H SB30	1
12	S3-21705	Stabiliser Housing SB30	1
13	HC-26057	Kit Cylinder Hyd Stab Tilt SB30/33	1
14	HC-26056	Kit Cylinder Hyd Stab Ext Mk6/SB30	1
15	S3-21657	Stabiliser Extension SB30	1
16	S1-18365	Support Lower Stabiliser Leg Cyl MK6	2
17	S3-21833	Foot SB30	1
18	PN-21819	Pin A & D SB30 Ø60	2
19	FA-28935	Circlip 60mm	11
20	PN-21821	Pin C E & F SB30 Ø60	3
21	PN-21822	Pin G SB30 Ø60	1
22	S3-21824	Plate Keeper Pin G SB30	2
23	PN-21812	Pin B & I SB30	2
24	PN-21826	Pin L SB30 Ø60	1
25	PN-21823	Pin H SB30 Ø60	1
26	PN-18322	Pin J MK6 SB30 Ø45	1
27	FA-28923	Circlip External M45	2
28	PN-21817	Pin K SB30 Ø45	1
29	S1-21933	Bracket Control Valve	1
30	S3-25977	Retainer Wear Pad Crane Base SB33	2
31	HC-26090	Danfoss valve PVEM	1
32	FA-27891	Pin Roll M10 X 55	2
33	S1-20829	Wear Pad Side Crane Base MK6	4
34	S3-26092	Wear Pad Crane Base 10mm SB33	4
35	TP-22361	Ball Steel	2
36	TP-22382	Spring Twistlock Centre	2
37	FA-28750	Screw Grub M10 X 012	2
38	S1-22507	Shim 60 I.D. X 75 O.D. X 1mm SB30	1
39	S1-22508	Shim 60 I.D. X 75 O.D. X 2mm SB30	1
40	S1-22509	Shim 60 I.D. X 75 O.D. X 5mm SB30	1
41	HC-20674	Clamp Double 16mm Pipe	5
42	HC-18602	Clamp Single 16mm Pipe	13
43	FA-28604	Screw Set Hex Gr 8.8 M8X20 ZP	18
44	FA-28827	Washer Flat M8X19 ZP	28
45	HC-25811	Clamp Double 1/2 Hose Plastic Dipped	10
46	FA-29759	Screw Socket Cap Gr 12.9 M8X20 ZP	10



Item	Part Number	Description (SB300)	Qty
47	FA-28838	Washer Flat M12X28.5 ZP	8
48	FA-28647	Bolt Hex Gr 8.8 M12X80 ZP	4
49	FA-28772	Nut Nyloc M12 ZP	4
50	FA-28730	Screw Socket Flat Head Gr 12.9 M6X20 ZP	4
51	S3-26156	Shim Load Transfer Foot 3mm SB30/33	2
52	S3-26155	Shim Load Transfer Foot 2mm SB30/33	2
53	S3-26154	Shim Load Transfer Foot 1mm SB30/33	2
54	S3-22162	Block Load Transfer 12mm Flange SB30	2
55	S3-22161	Block Load Transfer 20mm Flange SB30	2
56	FA-28711	Screw Socket Cap Gr 12.9 M8X80 Blk	6
57	S6-20471	Spacer Washer MK6 A&H Pin 4mm	1
58	S6-25959	Spacer Washer MK6 A&H Pin 2mm	1
59	S6-25958	Spacer Washer MK6 A&H Pin 1mm	1
60	S3-25981	Crane Base R/H SB33	1
61	S3-25967	Plate Bash Bottom Arm R/H SB33	1
62	HC-26058	Kit Cylinder Hyd Top Lift R/H SB30/33	1